



**PROGRAMMABLE,  
DIGITAL, WIDE-RANGE  
AJUSTABLE CURRENT & DIMMING  
CLASS P LISTED**

Constant Current LED Driver

**Model Number  
AC-30CD700APXL**

Input Voltage: 120-277V  
Input Frequency: 50/60Hz  
Side Mount/Lead  
< 1 Sec. Start time

**Dim-to-1% (Default)@Max Current**

**ELECTRICAL SPECIFICATIONS:**

Output Power	Input Power	Input Current	Min PF (full load)	Max THD (full load)	Output Voltage	Output Current	T case Max	Min Starting Temp**	Efficiency Up To	Dimming Protocol	Dimming Range	IP Rating
30W	36.5W	0.3A@120V 0.13A@277V	>0.9	<20	24-43V	125mA- 700mA	90°C	-40°C	82%	0-10V	1 to 100%	64

\*\* This driver can operate down to -40°C in a non-dimming condition. Below 0°C some flicker may be observed.

**WIRING:**

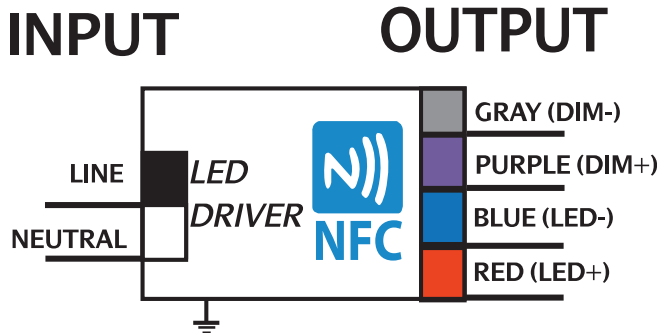

Lead Lengths					
Black	5.9"	Blue	5.9"	Purple	7.1"
White	5.9"	Red	5.9"	Gray	7.1"

**PHYSICAL:**

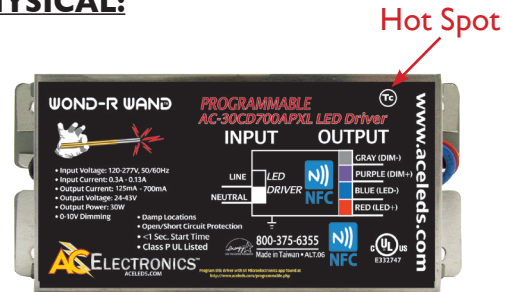

Dimensions	Length	Width	Height	Mounting
AC-30CD700APXL	5.23"	2.48"	1.18"	4.84"

Tref Max Value (°C)	Tc/Tref Value (°C)	Ta/Value (°C)
90	58.5	40

**SAFETY:**

- Class P Listed
- Class A sound rating
- Overload Protection
- UL Class 2
- Open/Short Circuit Protection
- LED driver has a life expectancy of 50,000 hours at Tcase of ≤75°C
- LED driver has a life expectancy of 100,000 hours at Tcase of ≤65°C
- Warranty: 5 yrs based on max case temp of <75°C; 3 yrs based on max case temp of 90°C\*
- Input/Output Isolation
- FCC Title 47 CFR Part 15
- Surge Protection (2 KV)
- Dim-To-Off Programming Option
  - o Active: Code = 62 02 01 07
  - o Inactive: Code = 62 02 00 07

**INSTALLATION:**

- Max Remote installation distance is 18 ft
- LED driver cases should be grounded
- LED drivers shall be installed inside electrical enclosures
- 18 AWG 600V/I05C tinned stranded copper lead-wires are required for installation



\*AC Electronics/AC LED Power Designs warrants to the purchaser that each LED Driver will be free from defects in material or workmanship for a period of 5 years when operated at max case temp of up to <75°C; 3 years from date of manufacture when operated at a max case temp of up to 90°C when properly installed and under normal conditions of use. See [aceleds.com](http://aceleds.com) for complete warranty policy.

**3401 Avenue D, Arlington, TX 76011 • 800-375-6355 • www.aceleds.com**

Data is based upon tests performed by AC Electronics in a controlled environment and representative performance. Actual performance can vary depending on operating conditions. Specifications are subject to change without notice. All specifications are nominal unless otherwise noted.



Use with NFC-V Reader App Available Free at Google App Store

### Phone Instructions

First you must have a Android device (phone/tablet) with NFC-V app downloaded.  
Open App; then place the device on top of the driver matching up sensors until it syncs up

Basic format

Write

Insert the appropriate code from chart above

Write

Successfully written will appear



To Check: Read

Read

Shows the Block - 00 00 00 00

This is where the code you input appears

### IOUT/VOUT CURVE

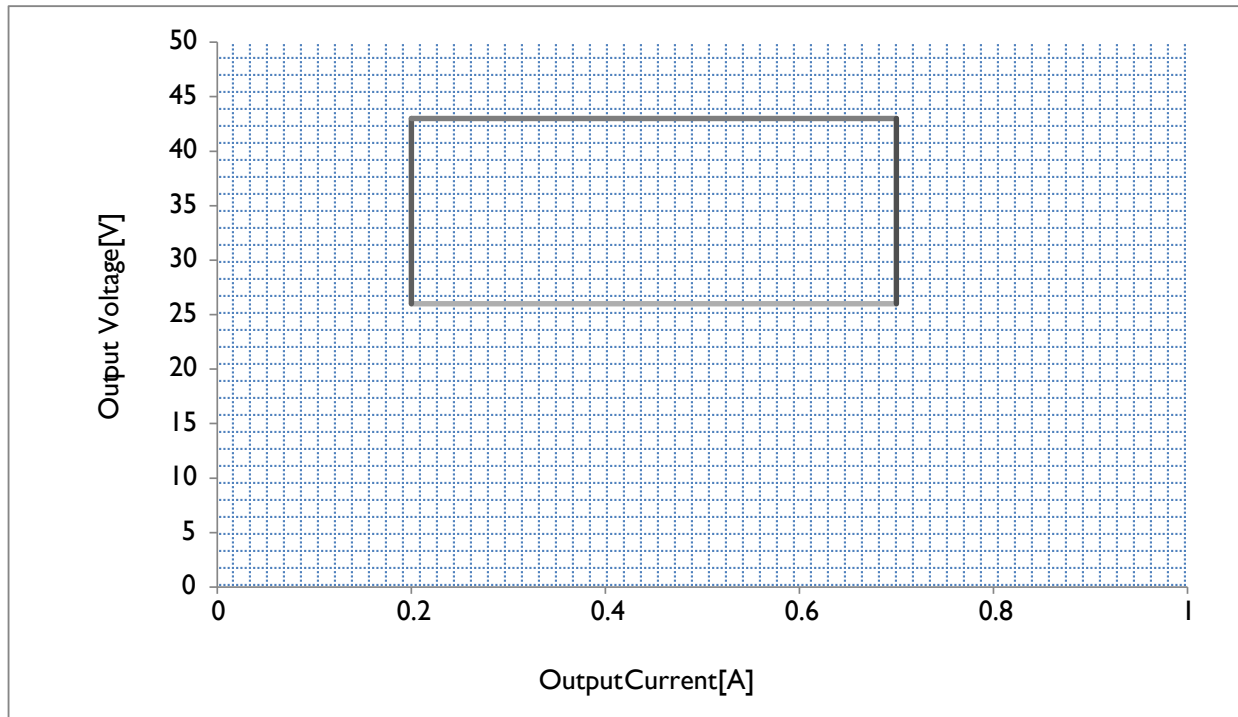

**CONTROL THE IOUT WITH THE PROGRAMMING WAND. DOWNLOAD SOFTWARE FROM <http://www.aceleds.com/products-programmable.php>**

3401 Avenue D, Arlington, TX 76011 • 800-375-6355 • [www.aceleds.com](http://www.aceleds.com)

Data is based upon tests performed by AC Electronics in a controlled environment and representative performance. Actual performance can vary depending on operating conditions. Specifications are subject to change without notice. All specifications are nominal unless otherwise noted.

Life Time v.s. Case Temperature Curve

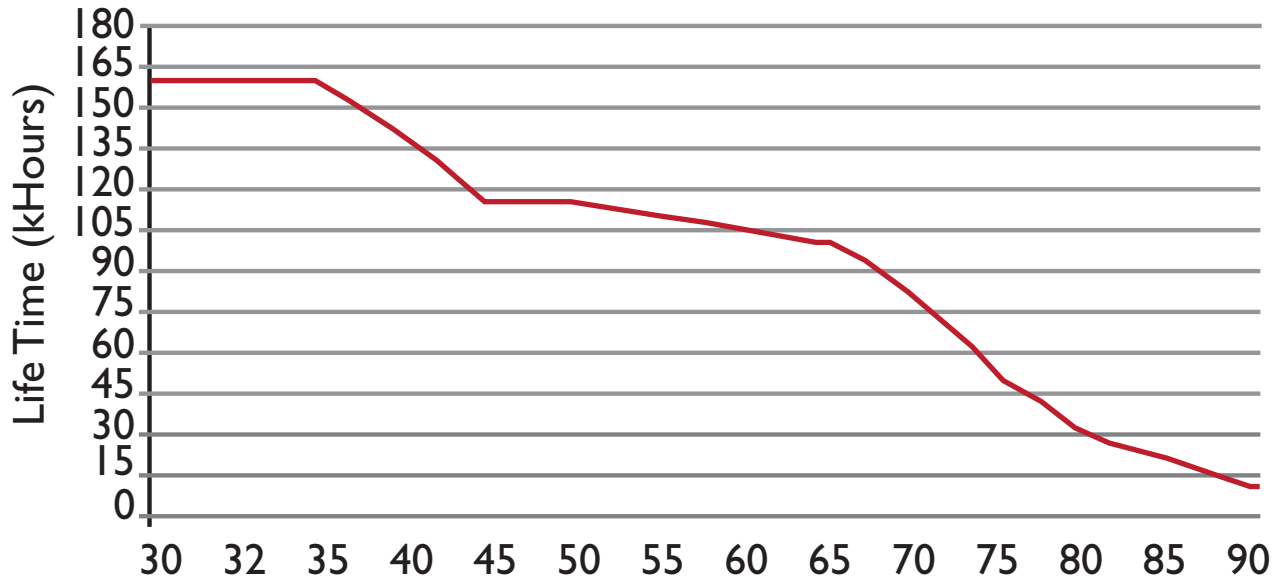

Case Temperature Curve (°C)

Derating Curve

120Vac & 277Vac

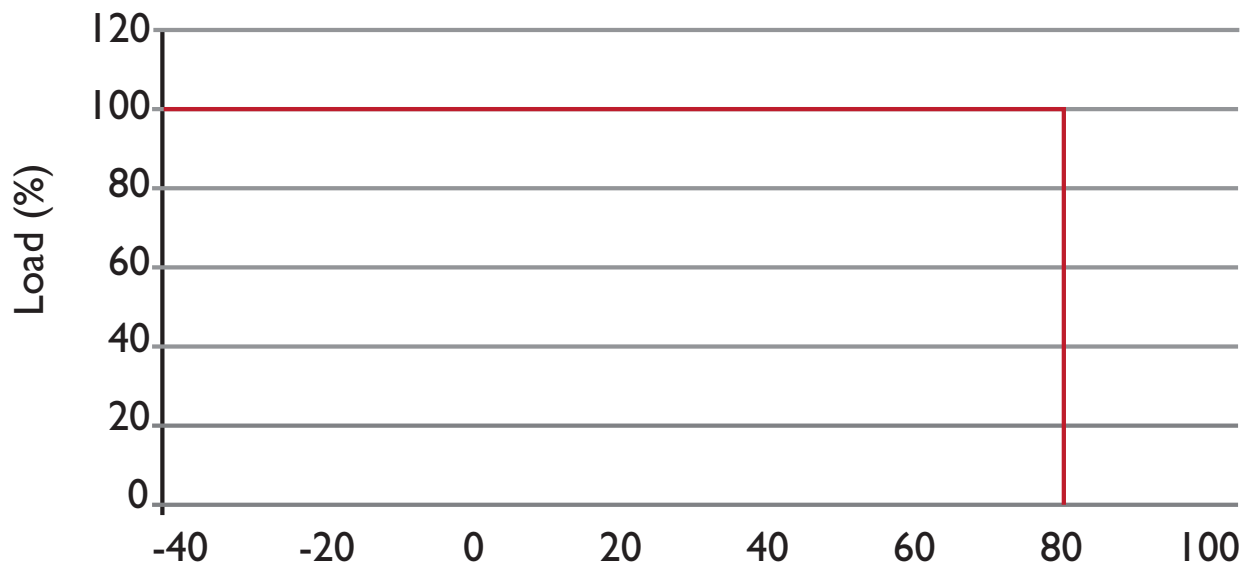

Outside Driver Ambient Temperature (°C)

3401 Avenue D, Arlington, TX 76011 • 800-375-6355 • [www.aceleds.com](http://www.aceleds.com)

Data is based upon tests performed by AC Electronics in a controlled environment and representative performance. Actual performance can vary depending on operating conditions. Specifications are subject to change without notice. All specifications are nominal unless otherwise noted.

Efficiency v.s. Load

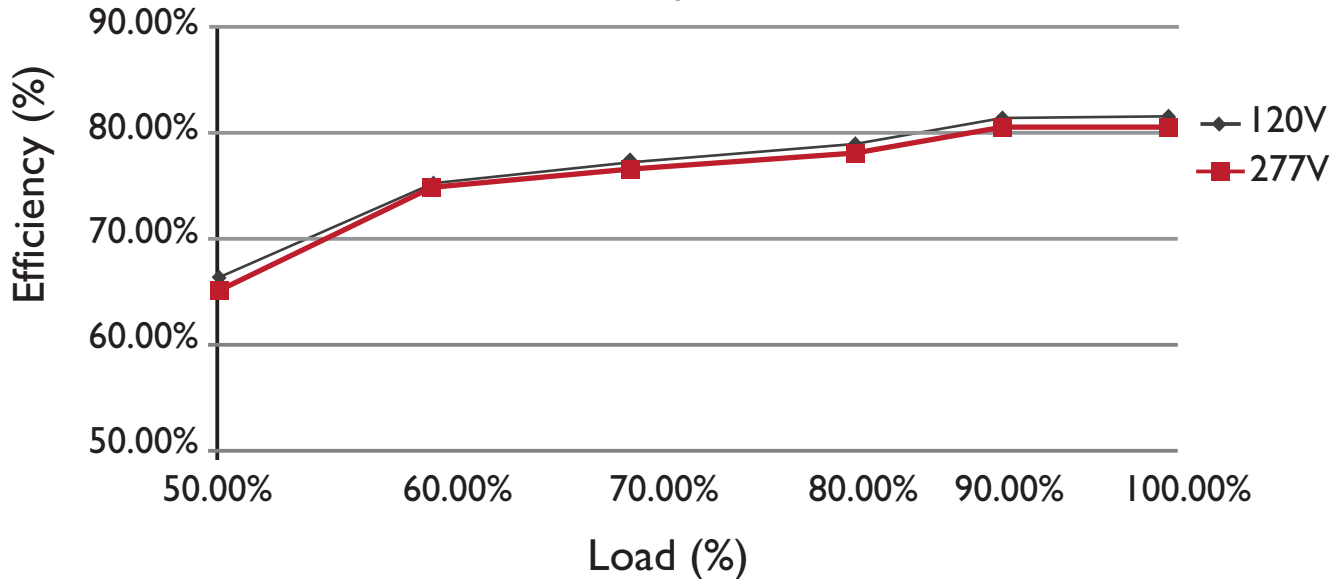

Power Factor v.s. Load

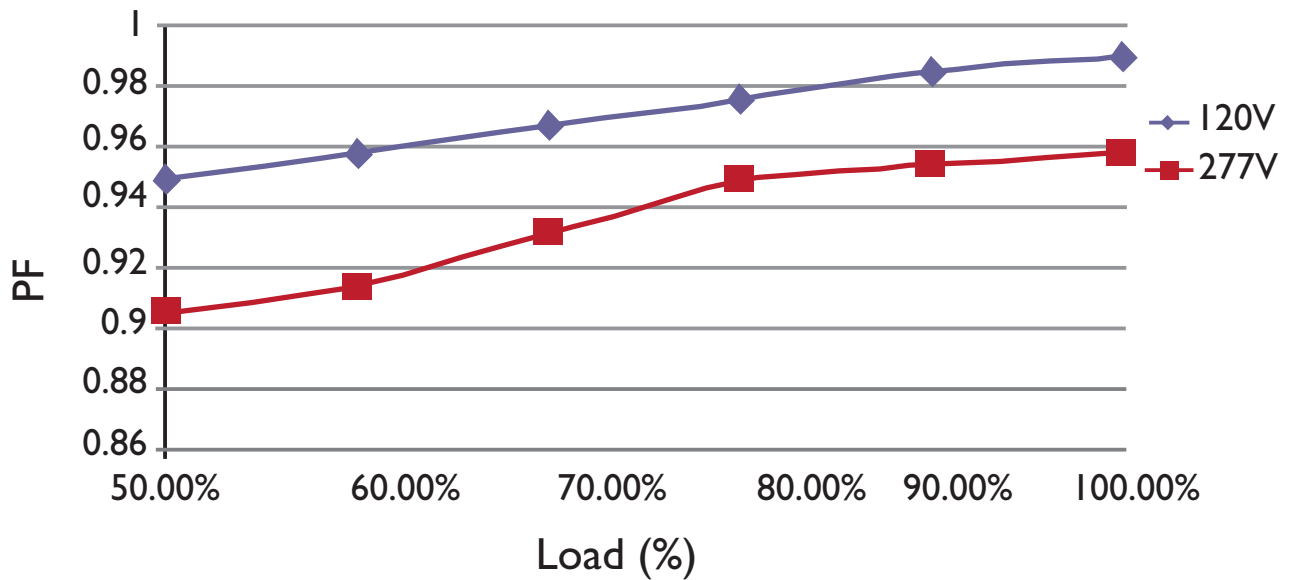

3401 Avenue D, Arlington, TX 76011 • 800-375-6355 • [www.aceleds.com](http://www.aceleds.com)

Data is based upon tests performed by AC Electronics in a controlled environment and representative performance. Actual performance can vary depending on operating conditions. Specifications are subject to change without notice. All specifications are nominal unless otherwise noted.

Output Current v.s. Dimming

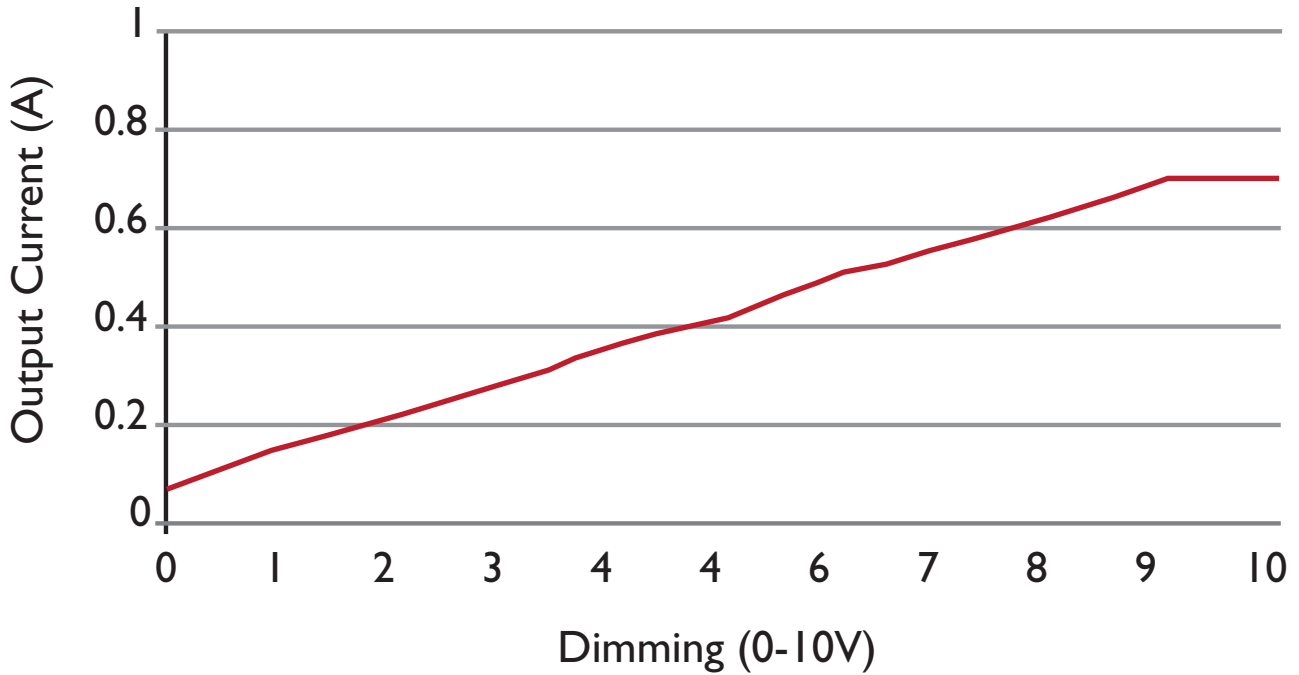

Output Current v.s. Resistance

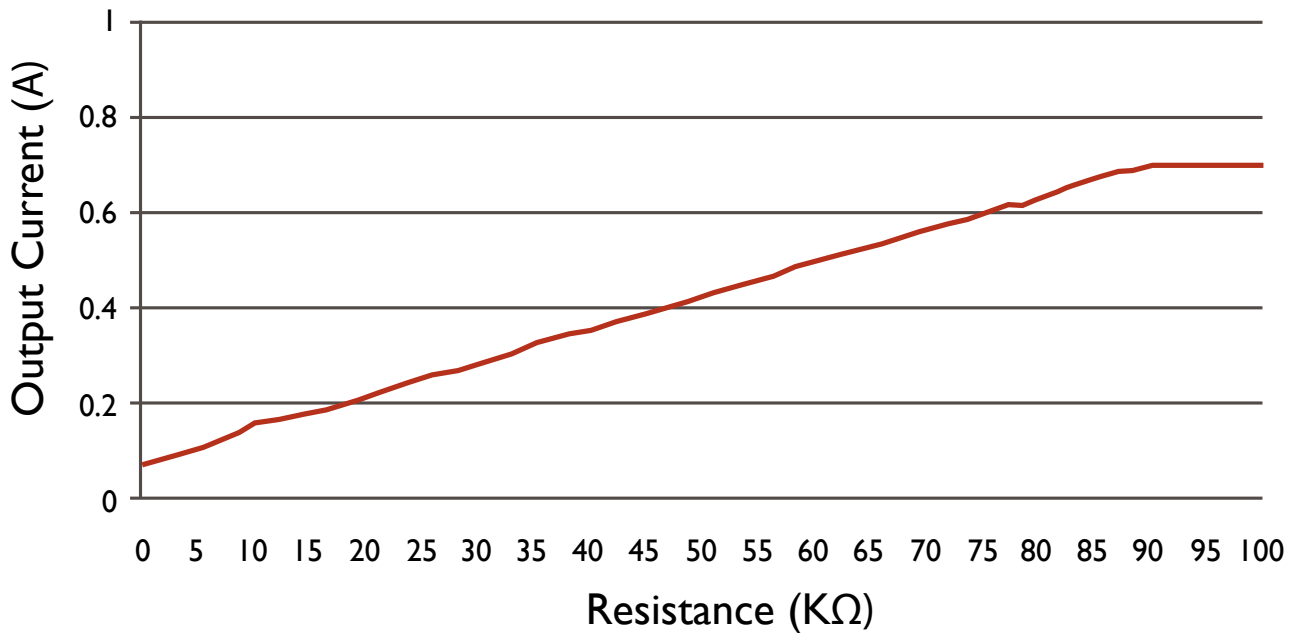

3401 Avenue D, Arlington, TX 76011 • 800-375-6355 • [www.aceleds.com](http://www.aceleds.com)

Data is based upon tests performed by AC Electronics in a controlled environment and representative performance. Actual performance can vary depending on operating conditions. Specifications are subject to change without notice. All specifications are nominal unless otherwise noted.