

ELECTRICAL SPECIFICATIONS:

Output Power Max.	Input Power	Input Current	Minimum PF (full load)	Max. THD (full load)	Output Voltage	Output Current	T case Max.	Minimum Starting Temp.	IP Rating	Efficiency Up To	Dimming Protocol	Dimming Range
50W	57W	0.6A@120V 0.2A@347V	>0.9	<20	22-36V	1400mA +/-5%	90°C	-40°C	64	87%	0 to 10V	1 to 100%
38W	45W	0.38A@120V 0.13A@347V	>0.9	<20	22-36V	1050mA +/- 5%	90°C	-40°C	64	85%	0 to 10V	1 to 100%
25W	30W	0.25A@120V 0.09A@347V	>0.9	<20	22-36V	700mA +/- 5%	90°C	-40°C	64	84%	0 to 10V	1 to 100%

WIRING:

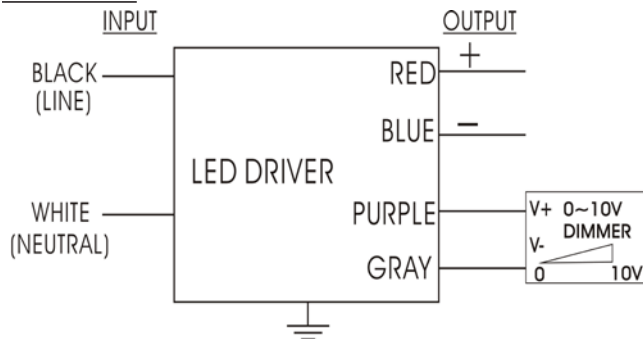

Lead Lengths

Black	5.9"	Blue	5.9"	Purple	7.1"
White	5.9"	Red	5.9"	Gray	7.1"

PHYSICAL:



Dimensions

Length	6.5"
Width	2.9"
Height	1.18"
Mounting Length	5.9"

SAFETY & PERFORMANCE:

- Class P Listed
- Class A sound rating
- No PCBs
- IP64
- Open/Short Circuit Protection
- LED driver has a life expectancy of 50,000 hours at Tcase of ≤75°C
- LED driver has a life expectancy of 100,000 hours at Tcase of ≤65°C
- Warranty:
- 5 years based on max case temp of 90°C*
- Input/Output Isolation
- FCC Title 47 CFR Part 15
- Surge Protection (3 KV)

INSTALLATION:

- LED drivers shall be installed inside UL approved electrical enclosures
- 18 AWG 600V/105C tinned strand copper lead-wires are required for installation
- Max Remote installation distance is 18 ft
- LED driver cases shall be grounded



*AC Electronics/AC LED Power Designs warrants to the purchaser that each LED Driver will be free from defects in material or workmanship for a period of 5 years when operated at max case temp of up to <75°C; 3 years from date of manufacture when operated at a max case temp of up to 90°C when properly installed and under normal conditions of use. See aceleds.com for complete warranty policy.

3401 Avenue D, Arlington, TX 76011 • 800-375-6355 • www.aceleds.com

Data is based upon tests performed by AC Electronics in a controlled environment and representative performance. Actual performance can vary depending on operating conditions. Specifications are subject to change without notice. All specifications are nominal unless otherwise noted.

