

**ELECTRICAL SPECIFICATIONS:**

Output Power Max.	Input Power	Input Current	Minimum PF (full load)	Max. THD (full load)	Output Voltage	Output Current	T case Max.	Minimum Starting Temp.	IP Rating	Efficiency Up To	Dimming Protocol	Dimming Range
50W	57W	0.6A@120V 0.21A@347V	>0.9	<20	22-36V	1400mA +/-5%	90°C	-40°C	64	87%	1 to 10V	1 to 100%
38W	45W	0.38A@120V 0.13A@347V	>0.9	<20	22-36V	1050mA +/- 5%	90°C	-40°C	64	85%	1 to 10V	1 to 100%
25W	30W	0.25A@120V 0.09A@347V	>0.9	<20	22-36V	700mA +/- 5%	90°C	-40°C	64	84%	1 to 10V	1 to 100%

**WIRING:**

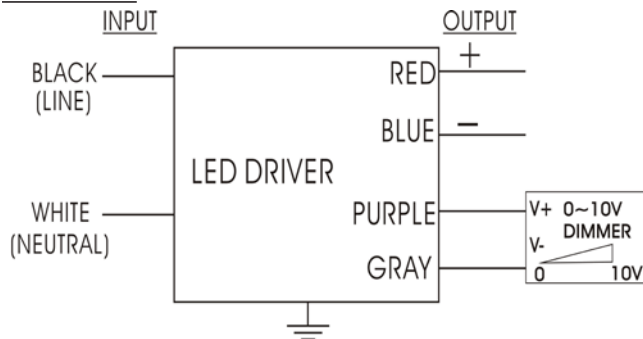

**Lead Lengths**

Black	5.9"	Blue	5.9"	Purple	7.1"
White	5.9"	Red	5.9"	Gray	7.1"

**PHYSICAL:**



**Dimensions**

Length	12.8"
Width	1.34"
Height	1.14"
Mounting Length	12.5"

**SAFETY & PERFORMANCE:**

- Class P Listed
- Class A sound rating
- No PCBs
- IP64
- Open/Short Circuit Protection
- LED driver has a life expectancy of 50,000 hours at Tcase of ≤75°C
- LED driver has a life expectancy of 100,000 hours at Tcase of ≤65°C
- Warranty:
- 5 years based on max case temp of 90°C\*
- Input/Output Isolation
- FCC Title 47 CFR Part 15
- Surge Protection (3 KV)

**INSTALLATION:**

- LED drivers shall be installed inside UL approved electrical enclosures
- 18 AWG 600V/105C tinned strand copper lead-wires are required for installation
- Max Remote installation distance is 18 ft
- LED driver cases shall be grounded



\*AC Electronics/AC LED Power Designs warrants to the purchaser that each LED Driver will be free from defects in material or workmanship for a period of 5 years when operated at max case temp of up to <75°C; 3 years from date of manufacture when operated at a max case temp of up to 90°C when properly installed and under normal conditions of use. See [aceleds.com](http://aceleds.com) for complete warranty policy.

3401 Avenue D, Arlington, TX 76011 • 800-375-6355 • [www.aceleds.com](http://www.aceleds.com)

Data is based upon tests performed by AC Electronics in a controlled environment and representative performance. Actual performance can vary depending on operating conditions. Specifications are subject to change without notice. All specifications are nominal unless otherwise noted.

