



INSTALLATION INSTRUCTIONS IMPORTANT SAFEGUARDS

CONSTANT
POWER

FOR MODELS: ACEPG6.51255CP, ACEPG101555CP, ACEPG10N1555CPB, ACEPG10N1555CP, ACEPG14N1555CP, ACEPG201555CP, ACEPG1030130CP, ACEPG61555BSPCP, ACEPG10T1555CP, ACEPG10L1555CP, ACEPG41255CP, ACEPG41255CP8, ACEPG10L1555CPB, ACEPG101555CPB, ACEPG61555BCP, ACEPG101555BEPC, ACEG101555BEMC, ACEPG101255CP, ACEPG101555CPG, ACEPG20M1555CP

Emergency LED driver

INSTRUCTION MANUAL IMPORTANT SAFEGUARDS

When using electrical equipment, basic safety precautions should always be followed, including the following:

READ AND FOLLOW ALL SAFETY INSTRUCTIONS:

1. To reduce the risk of electrical shock, disconnect both normal and emergency power sources before servicing.
2. This is a sealed unit. Replace the entire unit when necessary.
3. Installation and servicing should be performed by qualified personnel only.
4. This unit must be grounded. See the wiring diagrams for details.
5. This unit must be connected to the unswitched normal source of power with a nominal voltage of 120 – 277 Vac, 50/60 Hz, or 120 - 347 Vac, 50/60 Hz or 347 - 480 Vac, 50/60 Hz.
6. This unit must be fed from the same branch circuit as the AC LED driver during normal mode.
7. This unit should be mounted in locations and heights where it will not readily be subjected to tampering by unauthorized personnel.
8. This unit is suitable for factory or field installation.
9. This unit is suitable for use in damp locations where the ambient temperature is in the range of 0 °C minimum (or -20 °C minimum for “T” models) to 55 °C maximum. This product is also suitable for use in sealed and gasketed fixtures.
10. This unit is not suitable for heated air outlets, wet, or hazardous locations.
11. Use of accessory equipment not recommended by the manufacturer may cause an unsafe condition, void the warranty, or result in non-compliance with regulations.
12. Do not mount near gas or electric heaters. Do not use this product outdoors or for any use other than its intended use.
13. Install in accordance with the National Electrical Code and local regulations.

SAVE THESE INSTRUCTIONS



Emergency LED driver
for use with suitable
LED luminaires



Certified in CA Title 20
Appliance Efficiency
Database – Battery Charger



Complies to FCC
commercial limits



Li-ion

This product contains a
rechargeable Lithium-ion battery.
The battery must be recycled or
disposed of properly.



3401 Avenue D, Arlington, TX 76011 • 800-375-6355 • aceleds.com

Data is based upon tests performed by AC Electronics in a controlled environment and representative performance. Actual performance can vary depending on operating conditions. Specifications are subject to change without notice. All specifications are nominal unless otherwise noted.



INSTALLATION INSTRUCTIONS

CAUTION: **BEFORE INSTALLING, MAKE CERTAIN THE AC POWER IS OFF.**

NOTE: Make sure the necessary branch circuit wiring is available. An unswitched source of power is required. The emergency LED driver must be fed from the same branch circuit as the AC LED driver.

This product is suitable for field installation with compatible LED luminaires and LED loads. The following items need to be checked to determine if the LED luminaire is suitable for field installation.

- A.** Ensure that the rated power of the LED load is greater than or equal to the power output of the emergency LED driver so that the LED load is not overpowered in emergency mode. See individual model specifications to determine the output power.
- B.** Verify that the forward voltage (Vf) of the luminaire's LED array (LED load) is within the limits of the emergency LED driver's output operating range.
- C.** Ensure that the output current of the AC LED driver does not exceed the value specified for the individual model.
- D.** Ensure that there will be sufficient emergency egress lighting illumination levels per national, state, and local codes. Use the following guidelines.
 - 1.)** Determine the efficacy (lm/W) of the LED load. This information is typically given by the luminaire manufacturer in lumens per Watt (lm/W or LPW). It can also be obtained by direct measurement or published in a 3rd party database such as UL, Design Lights Consortium (www.designlights.org), or other qualifying means.
 - 2.)** The light output of the LED load in lumens can be calculated by multiplying the output power (W) by the efficacy of the LED load (lm/W). This will provide a conservative estimate and serve well as a beginning point for the emergency lighting design. Use the following equation and example as a guide:

**Lumens in emergency mode (lm) =
(emergency LED driver output power (W)) x (LED load efficacy (lm/W))**

Example: Given: Emergency LED driver output power = 10 W
LED load efficacy = 100 lm/W

Then: **Lumens in emergency mode = 10 x 100 = 1000 lm**

Note: The above serves only as an example, actual results will depend on the specific data for the specific application.

- 3.)** Once the light output (lm) is determined, use industry standard lighting design tools to estimate the illumination levels for the emergency egress path.

Note: These products are compatible with most LED fixtures and LED loads that meet criteria A, B, and C above. However, predetermined interoperability and compatibility cannot be guaranteed. Compatibility and interoperability testing for the end-use application is recommended. Please contact the factory should there be questions.

Note: After installation, it is necessary that the emergency egress lighting illumination levels be measured to ensure compliance with national, state, and local codes.

Mounting Height: This product meets or exceeds the NFPA minimum light requirements with all loads, down to the smallest rated lamp load, at heights up to 7.17ft (2.2m). Many factors influence emergency illumination levels, such as the lamp load selected, luminaire design, and environmental factors therefore end use verification is necessary. For field installations, when the attached luminaire is mounted at heights greater than 7.17ft (2.2m), the level of illumination must be measured in the end application to ensure the requirements of NFPA 101 and local codes are satisfied.



3401 Avenue D, Arlington, TX 76011 • 800-375-6355 • aceleds.com

Data is based upon tests performed by AC Electronics in a controlled environment and representative performance. Actual performance can vary depending on operating conditions. Specifications are subject to change without notice. All specifications are nominal unless otherwise noted.

Installation of this emergency LED driver may vary from one luminaire type to another; however, the following steps generally apply:

Step 1.) Installing the emergency LED driver

- Ensure that AC power is disconnected from the LED luminaire.
- Mount the emergency LED driver by the mounting tabs using the supplied hardware. See Illustration 1.

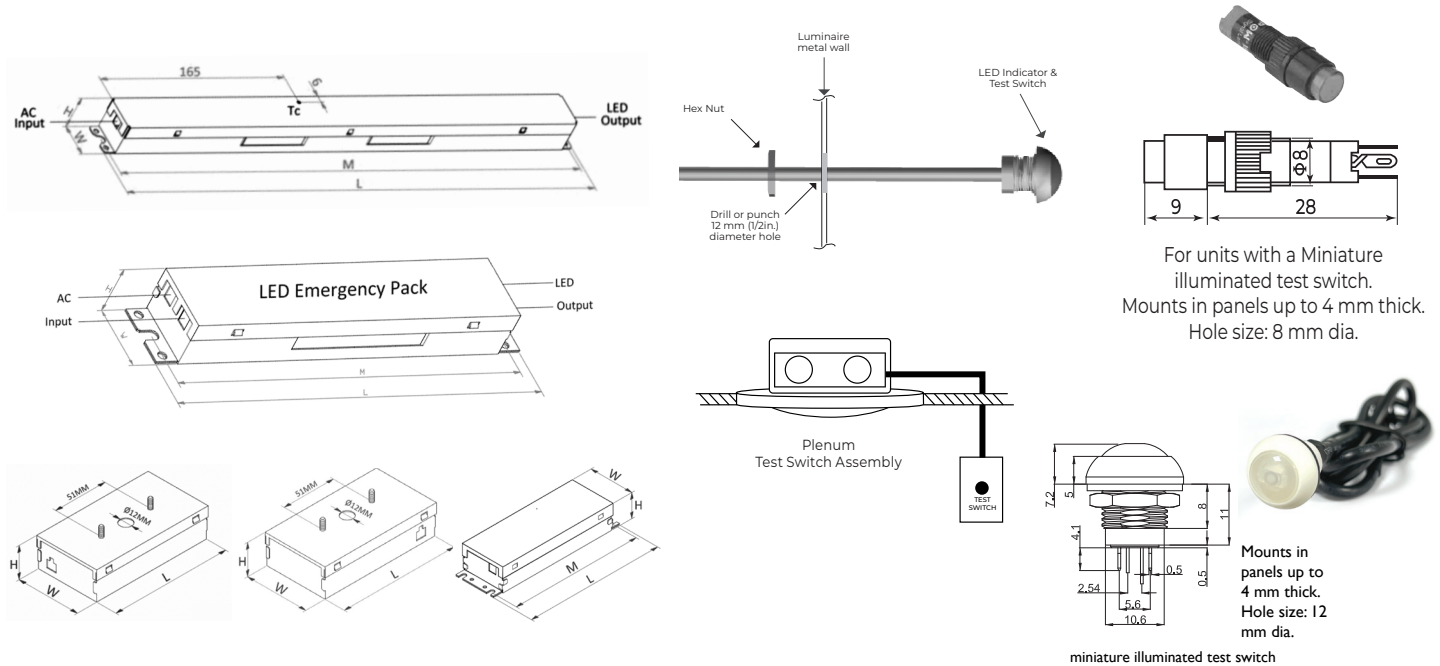

Illustration 1.

See the individual product specifications for unit dimensions, location of Tc, and mounting tabs

Illustration 2.

LED Indicator & Test Switch

Wiring the Emergency LED driver

Step 2.) Wiring diagram selection: Select the appropriate wiring diagram.

Note: All wiring practices and connections should comply with the National Electrical Code and local safety guidelines and regulations.

Step 3.) Wiring the AC power input section: Refer to the wiring diagram for switching the switched hot AC power. The YELLOW/BLACK wire connects to the unswitched hot. One of the BLACK/WHITE wires connects to the switched hot. Note that it makes no difference which BLACK/WHITE wire is chosen. The other BLACK/WHITE wire connects to the hot lead (usually BLACK) of the AC LED Driver. The WHITE wire connects to the line neutral and to the neutral wire of the AC LED Driver.

For switching the neutral wire of the AC LED Driver, please refer to the wiring diagram for switching the neutral wire of the AC LED Driver. The YELLOW/BLACK wire connects to the unswitched hot. One of the BLACK/WHITE wires connects to the neutral wire of the AC LED Driver. The other BLACK/WHITE wire connects to the WHITE neutral wire and to the line neutral.

Step 4.) Wiring the output section: The emergency LED driver has 4 output wires: Connect the red (+) wire from the emergency LED driver output to the output positive (+) wire of the AC LED Driver. Connect the blue (-) wire from the emergency LED driver output to the output negative (-) wire of the AC LED Driver. Connect the white/red (+) wire from the emergency LED driver output to the positive terminal of the LED load. Connect the white/blue (-) from the emergency LED driver output to the negative terminal of the LED load.



OPERATION & MAINTENANCE

Step 5.) Installing the LED Indicator & test switch Mount the supplied LED Indicator & Test Switch in a location on the luminaire or mount it to a wall plate where it is visible and accessible by maintenance personnel.

Wire the LED Indicator & Test Switch per wiring diagrams provided in these instructions. After installing the LED Indicator & Test Switch, mark with the "PUSH TO TEST" and "CHARGING LED INDICATOR" labels.

Step 6.) Apply AC power: After the wiring connections and installation are complete, supply AC power to the luminaire. This unit includes the Power Activate feature. Upon installation, when AC power is initially applied, the unit self-activates, thereby establishing normal-mode operation. The LED indicator should illuminate indicating that the battery is charging correctly.

Step 7.) Final Step, test the emergency LED driver: After the emergency LED driver has charged for at least one hour, a short-term discharge test may be conducted by pressing and holding the test switch. The emergency LED driver should be allowed to charge for 24 hours before conducting a 90-minute discharge test.

OPERATION

Normal Mode: With the normal AC supply of power present, the AC LED driver operates as normal, and the emergency LED driver is in battery charging mode, as well as power loss monitoring mode.

Emergency Mode: In the event of a normal AC power failure, the emergency LED driver switches to emergency mode and operates the fixture's LED array or module for 90 minutes, or until normal power returns, whichever occurs first. When normal power returns, the emergency LED driver returns to normal mode.

TESTING AND MAINTENANCE

No routine maintenance is necessary to keep the emergency LED driver functional. However, periodic testing of emergency lighting equipment is required per NFPA-101.

1. While in normal mode, visually inspect that the LED Indicator is illuminated. If the LED Indicator is illuminating continuously, then that is an indication the battery is charging correctly.
2. A monthly test (with a minimum of 3 weeks and a maximum of 5 weeks between intervals) should be conducted for not less than 30 seconds. The emergency LED driver should properly operate the LED load for the full duration of this test.
3. An annual test should be conducted for a full 90 minutes. The emergency LED driver should properly operate the LED load for the full duration of this test.

TEST SWITCH OPERATION SUMMARY

AC Power	Test Switch Operation	Resulting Emergency LED Driver Status or State
With AC Power applied	None	Normal-mode
With AC Power applied	Press and hold the test switch	Emergency-mode test for the duration of holding the test switch
With AC Power removed	Press and hold the test switch for 2-3 seconds	The unit will be placed into sleep-mode which deactivates the unit and prepares the unit for shipping or storage

REFER ANY SERVICING INDICATED BY THESE CHECKS TO QUALIFIED PERSONNEL!



3401 Avenue D, Arlington, TX 76011 • 800-375-6355 • aceleds.com

Data is based upon tests performed by AC Electronics in a controlled environment and representative performance. Actual performance can vary depending on operating conditions. Specifications are subject to change without notice. All specifications are nominal unless otherwise noted.

WIRING DIAGRAM

MODELS: ACEPG6.51255CP, ACEPG101555CP, ACEPG10N1555CPB, ACEPG10N1555CP, ACEPG14N1555CP

A. TYPICAL WIRING DIAGRAM FOR SWITCHING THE SWITCHED HOT AC POWER FOR THE NORMAL AC LED DRIVER

A. DIAGRAMA DE CABLEADO TÍPICO PARA LA CONMUTACIÓN DE LA CORRIENTE CALIENTE CONMUTADA DE CA PARA EL CONTROLADOR DE LED DE CA NORMAL.

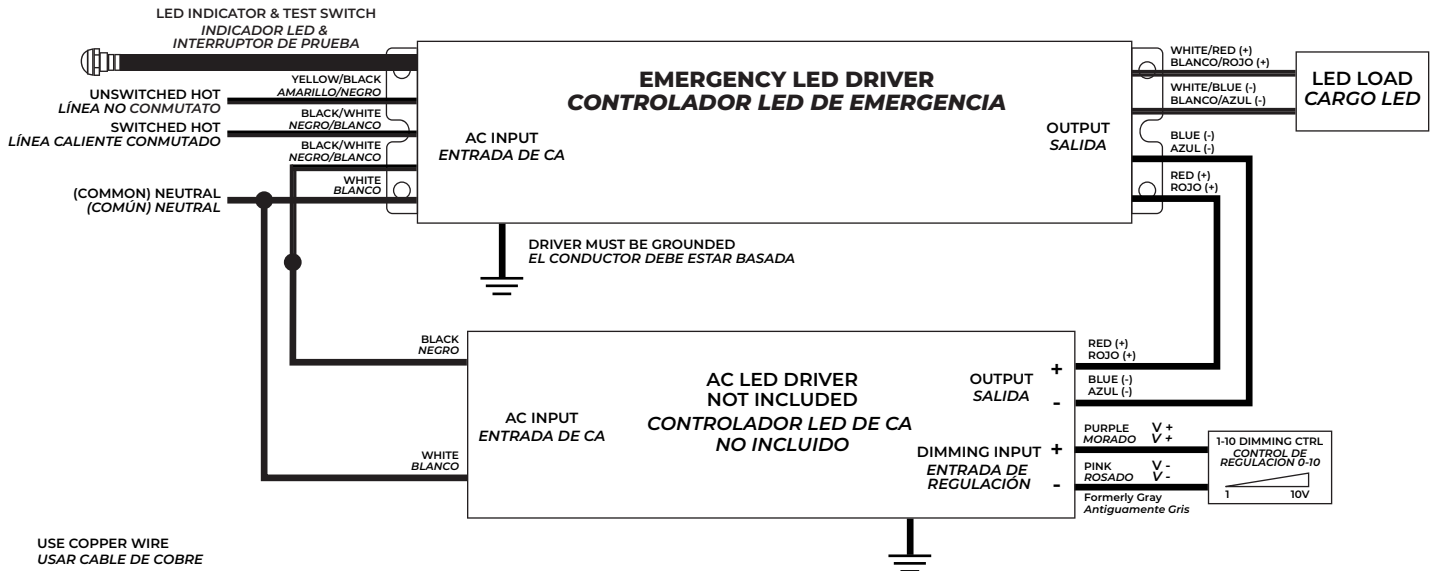

B. TYPICAL WIRING DIAGRAM FOR SWITCHING THE NEUTRAL WIRE OF THE NORMAL AC LED DRIVER

B. DIAGRAMA DE CABLEADO TÍPICO PARA CAMBIAR EL CABLE NEUTRAL DEL CONTROLADOR DE LED DE CA NORMAL.

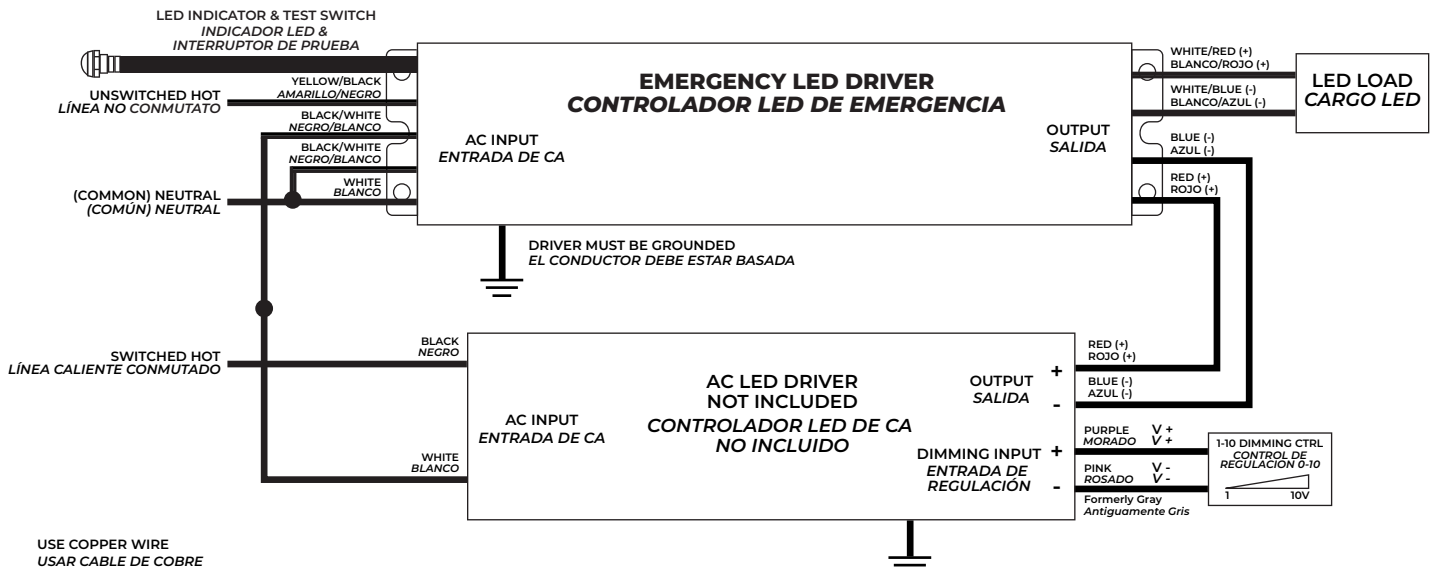

WIRING DIAGRAM

MODELS: ACEPG201555CP, ACEPG1030130CP, ACEPG10T1555CP, ACEPG101555CP, ACEPG41255CP, ACEPG10L1555CP, ACEPG41255CP8, ACEPG10L1555CPB, ACEPG101555CPB, ACEPG101255CP, ACEPG101555CPG, ACEPG20M1555CP

A. TYPICAL WIRING DIAGRAM FOR SWITCHING THE SWITCHED HOT AC POWER FOR THE NORMAL AC LED DRIVER
A. DIAGRAMA DE CABLEADO TÍPICO PARA LA CONMUTACIÓN DE LA CORRIENTE CALIENTE CONMUTADA DE CA PARA EL CONTROLADOR DE LED DE CA NORMAL.

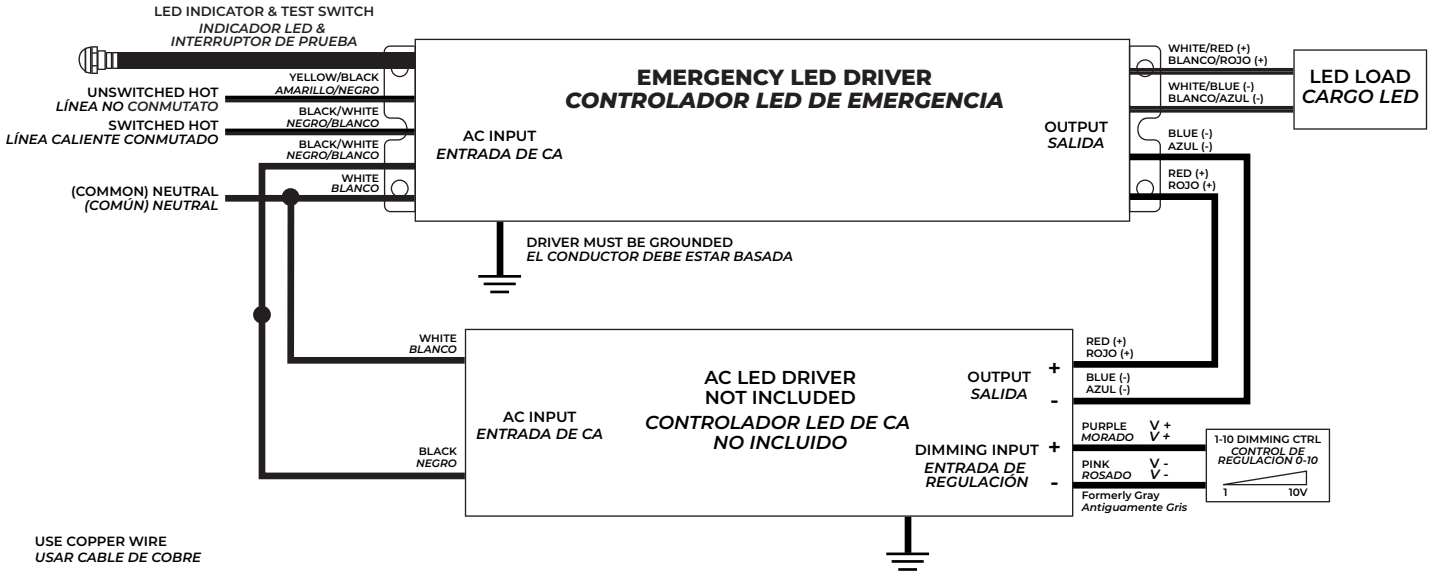

B. TYPICAL WIRING DIAGRAM FOR SWITCHING THE NEUTRAL WIRE OF THE NORMAL AC LED DRIVER
B. DIAGRAMA DE CABLEADO TÍPICO PARA CAMBIAR EL CABLE NEUTRAL DEL CONTROLADOR DE LED DE CA NORMAL.

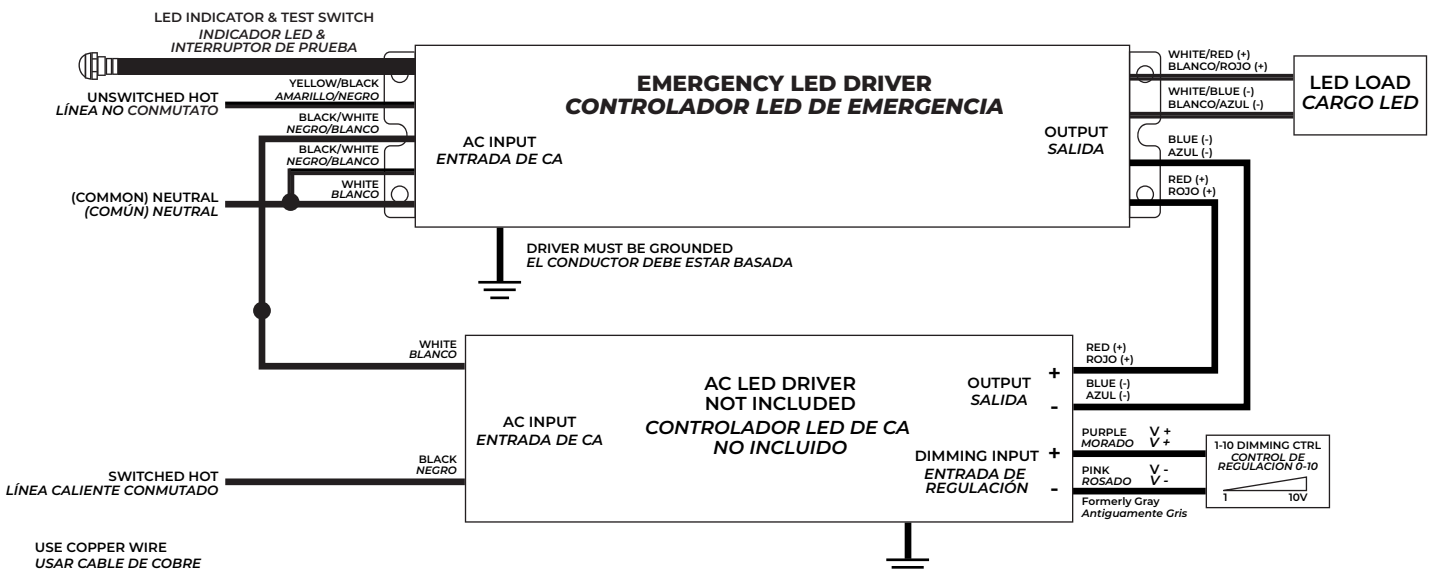

WIRING DIAGRAM

MODEL: ACEPG61555BSPCP, ACEPG1011555BEPC, ACEPG101555BEMC

A. TYPICAL WIRING DIAGRAM FOR SWITCHING THE SWITCHED HOT AC POWER FOR THE NORMAL AC LED DRIVER

A. DIAGRAMA DE CABLEADO TÍPICO PARA LA CONMUTACIÓN DE LA CORRIENTE CALIENTE CONMUTADA DE CA PARA EL CONTROLADOR DE LED DE CA NORMAL.

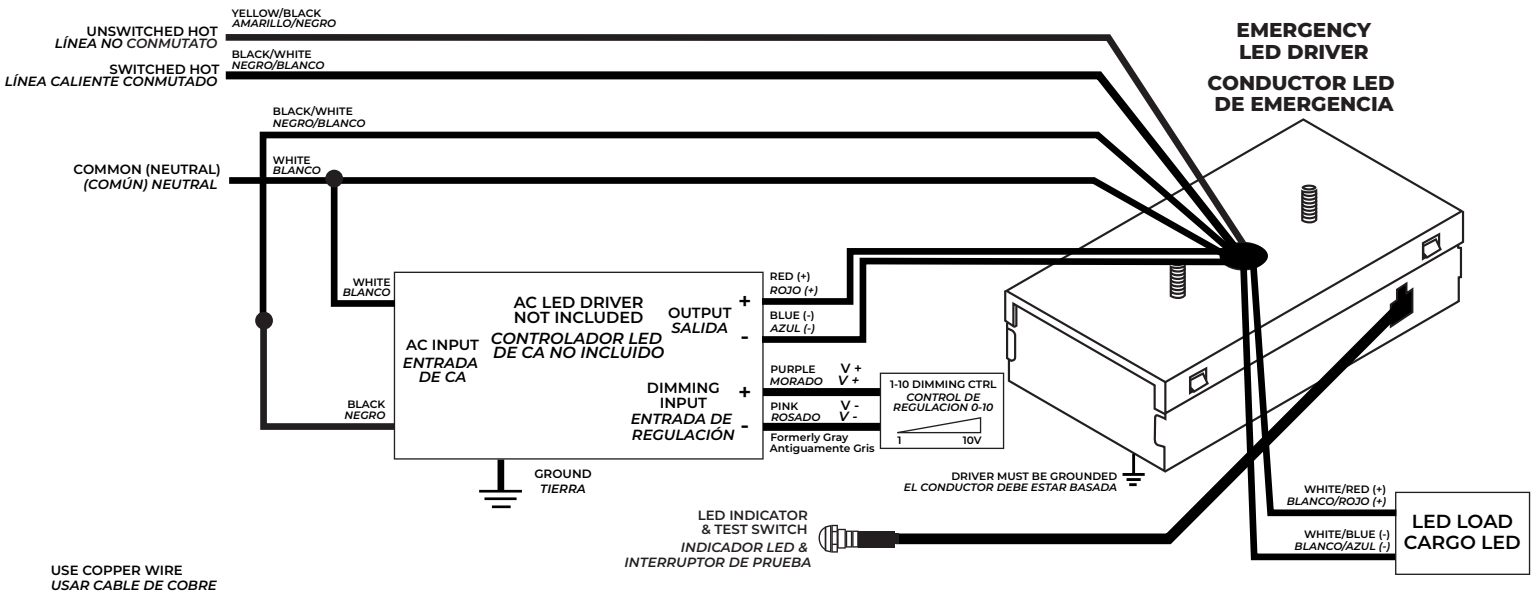

B. TYPICAL WIRING DIAGRAM FOR SWITCHING THE NEUTRAL WIRE OF THE NORMAL AC LED DRIVER

B. DIAGRAMA DE CABLEADO TÍPICO PARA CAMBIAR EL CABLE NEUTRAL DEL CONTROLADOR DE LED DE CA NORMAL.

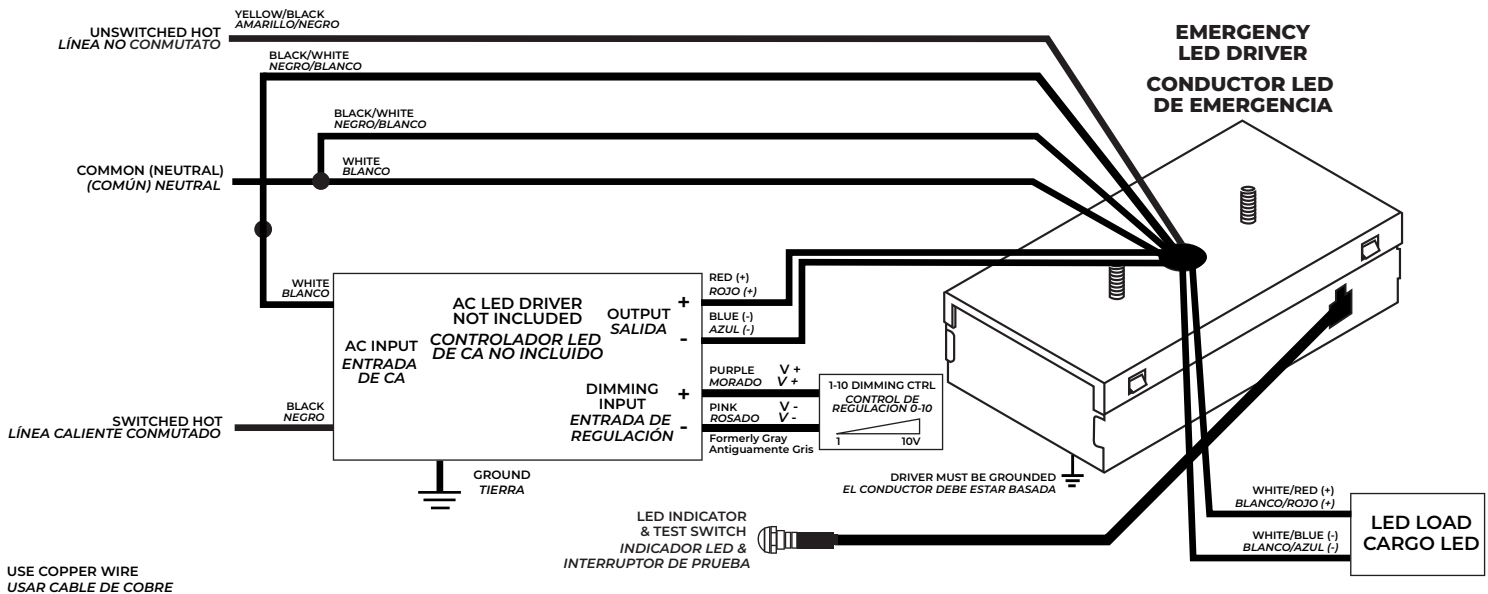

WIRING DIAGRAM

MODEL: ACEPG61555BCP

- A. TYPICAL WIRING DIAGRAM FOR SWITCHING THE SWITCHED HOT AC POWER FOR THE NORMAL AC LED DRIVER**
A. DIAGRAMA DE CABLEADO TÍPICO PARA LA CONMUTACIÓN DE LA CORRIENTE CALIENTE CONMUTADA DE CA PARA EL CONTROLADOR DE LED DE CA NORMAL.

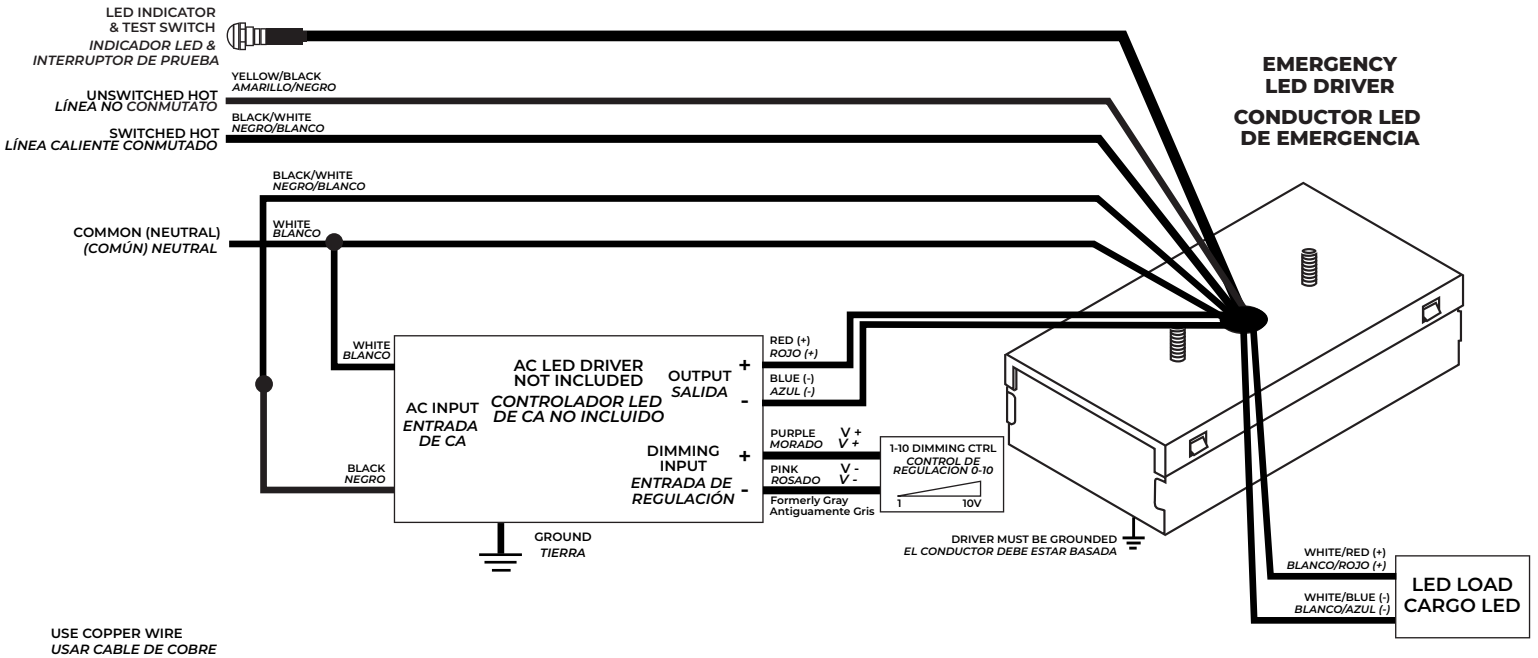

- B. TYPICAL WIRING DIAGRAM FOR SWITCHING THE NEUTRAL WIRE OF THE NORMAL AC LED DRIVER**
B. DIAGRAMA DE CABLEADO TÍPICO PARA CAMBIAR EL CABLE NEUTRAL DEL CONTROLADOR DE LED DE CA NORMAL.

