

**ACEPX16T1555CP Emergency LED Driver  
With Power Activate**



**Primary Specifications:**

**Cold Start**

Output Power Max	Input Power	Input Current Max	Emergency Operating Time	Battery	Input Voltage	Output Voltage	Ambient Operating Temperature	UL Listed for US and Canada
16 W	11 W	130 mA	90 min.	Lithium-ion 24 Hour recharge 7 to 10 year Life expectancy	120-277 Vac 50/60Hz	15-55 V <sup>1</sup>	-20 °C - 55 °C	UL and cUL (UL924) Emergency LED Driver



**Optional Power Activate, 16 W Chrome Test Switch Accessory:**



Please reference model number **ACEPX16T1555ECP** when ordering the Chrome Test Switch option.

**Description:**

The **ACEPX16T1555CP** from AC Electronics is a UL Listed Linear Emergency LED Driver that enables the same LED fixture to be used for both normal and emergency operation. The **ACEPX16T1555CP** contains a lithium-iron phosphate battery, a high-efficiency battery charger, control circuitry, and high-efficiency power converter circuits, in a two-piece modular arrangement of two separate metal enclosures. The **ACEPX16T1555CP** includes the Power Activate feature, which eliminates the external battery connector. Upon installation, when AC power is initially applied, the **ACEPX16T1555CP** self-activates, thereby establishing normal-mode operation. In the event of a normal power failure, the **ACEPX16T1555CP** switches to emergency-mode and operates the fixture's LED array or module for 90 minutes at a constant power of 16 W. When normal AC power returns, the **ACEPX16T1555CP** returns to normal-mode. The **ACEPX16T1555CP** can be used in switched or unswitched fixture applications. The **ACEPX16T1555CP** can drive any LED array or module in emergency-mode with a voltage range of 15-55 Vdc and that can operate at a current range of 290 mA to 1067 mA.

**Safety and Regulatory Compliance:**

- UL and cUL Listed as an Emergency LED Driver (UL924)
- UL Listed for both field and factory installation
- UL & cUL Class 2 output (UL1310 compliant)
- CEC Title 20 compliant: Certified in CA Title 20 Appliance Efficiency Database – Battery Charger
- EMI: Complies to FCC commercial limits
- RoHS compliant

**Additional Specifications:**

- Normal (ac) driver maximum output current:.....5 A<sup>2</sup>
- Output current range:.....290 mA to 1067 mA<sup>3</sup>
- Surge protection: .....3 kVp
- Maximum case temperature Tc: .....66 °C
- Nominal battery voltage:.....10.8 V
- Battery charge current: .....500 mA
- Metal enclosure IP rating:.....IP30
- Dimensions Converter: 5.23 in L x 2.48 in W x 1.18 in H x 4.84 in M
- Dimensions Battery:.....5.44 in L x 3.63 in W x 1.18 in H x 4.84 M

<sup>1</sup>The emergency-mode output voltage operating range is 15 - 55 V. The absolute maximum output voltage is 60 V to comply with class 2 regulations.

<sup>2</sup>The Normal (ac) Driver maximum output current is the maximum current allowed to pass through the **ACEPX16T1555CP** circuitry in Normal-mode.

<sup>3</sup>The emergency-mode output current adjusts to maintain a constant output power across the output voltage range.

\*Warranty: 5 years based on a maximum case temperature of ≤ 60 °C, 3 years warranty based on a maximum case temperature of ≤ 66 °C

**5-Year USA-Backed Warranty\***  
See complete AC Electronics/ACE LEDS Warranty information for details.

### Features, Benefits, and Applications:

- Constant output power: Maintains constant emergency light levels over the full 90-minute runtime and over the output voltage range.
  - Self-sensing output voltage: Adjusts over the 15-55 V range to maintain constant power within the class 2 voltage range.
  - Includes input over voltage surge protection, output short circuit, open circuit, and over-voltage protection, as well as over-temperature protection for improved reliability.
  - Two-wire universal input: Reduces wiring errors and reduces installation time and complexity.
  - Includes a miniature illuminated test switch status indicator: Enables mounting in small spaces.
  - Suitable for indoor and damp locations.
  - Compatible with a variety of LED fixtures, such as emergency-only fixtures, as well as new and existing fixtures.
  - Low profile design: Enables mounting in extremely small low profile luminaries.
  - Two-piece modular design: Provides the versatility to fit in small places.
- Power Activate feature eliminates the external battery connector. Unit self-activates upon initial installation power-up.

### Power Activate Feature:

The Power Activate feature eliminates the external battery connector.

#### **How it works:**

The “battery connector” is implemented internally, inside the unit as an internal electronic battery connector. The manual external battery connector has been removed from this unit. When AC power is applied for the first time to the unit, the internal electronic battery connector self-activates, engaging the battery. With AC power applied, the unit will charge its battery. Upon a normal power failure, the unit will switch to emergency-mode.

#### **How to de-activate the internal battery connector:**

Once a unit has been activated, it must be placed into sleep-mode (de-activated) prior to shipping or storage. With AC power removed from the unit, press and hold the test switch for 2-3 seconds, then release. The unit will then be placed into sleep-mode. Sleep-mode deactivates the unit and internally disconnects the battery to prepare the unit for shipping or storage. The Power Activate feature will reactivate upon installation when AC power is first applied.



### Manual Testing:

With AC power applied, while the unit is in Normal-Mode, manual testing can be performed as follows:

1. Push and hold the test switch. This transfers the unit into emergency-mode. The unit will remain in emergency-mode while the test switch is held closed.
2. Release the test switch to transfer the unit back to normal-mode.

### **Test Switch Operation Summary:**

AC Power	Test Switch Operation	Resulting Emergency LED Driver Status or State
With AC Power applied	None	Normal-mode
With AC Power applied	Press and hold the test switch	Emergency-mode test for the duration of holding the test switch
With AC Power removed	Press and hold the test switch for 2-3 seconds	The unit will be placed into sleep-mode which deactivates the unit and prepares the unit for shipping or storage



DC-DC CONVERTER

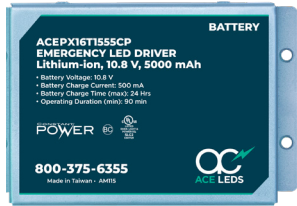

BATTERY

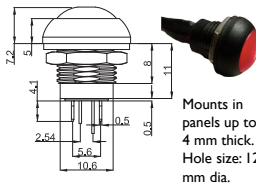

miniature illuminated test switch

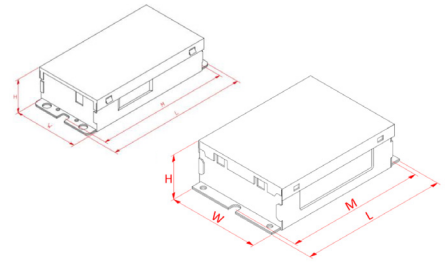

Lead Lengths					
White	6"	White/Red	6"	Purple Heater Control Wire	13.4"/13.4"
Yellow/Black	6"	White/Blue	6"	Battery Box Connector Wire/ EMB Connector Wire	3.5"/12.6"
Black/White	6"	Red	6"	Test Switch/ LED Indicator	7.08"/23.62"
Black/White	6"	Blue	6"		

Dimensions- DC-DC Converter			
Length	5.23"	Height	1.18"
Width	2.48"	Mounting Length	4.84"

Dimensions- Battery			
Length	5.44"	Height	1.58"
Width	3.63"	Mounting Length	5.12"

Constant output power performance over full 90 minutes run-time

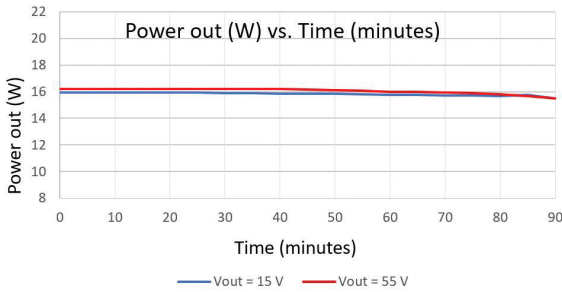

Constant output power performance over full output voltage range

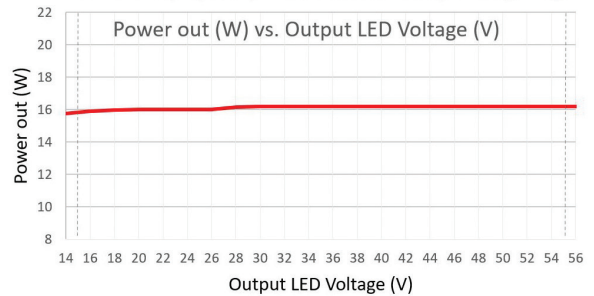

## INSTALLATION:

The **ACEPX16T1555CP** Linear Emergency LED Driver may be used with either a switched or unswitched fixture. An unswitched (constant hot) is required to charge the battery and to maintain a charge when normal AC power is available. The Linear Emergency LED Driver must be fed from the same branch circuit as the normal AC LED driver (if used). This Linear Emergency LED Driver must be installed where the ambient temperature is maintained between -20 - 55 °C (-4 - 131 °F). This unit must be installed inside an electrical enclosure, such as a luminaire. The **ACEPX16T1555CP**

Linear Emergency LED Driver comes in a single metal enclosure with a separate miniature illuminated test switch status indicator. This Linear Emergency LED Driver is suitable for installation in sealed and gasketed fixtures. The maximum remote mounting distance to the LEDs is 18 feet. The Linear Emergency LED Driver metal case should be grounded. Stranded copper wires, 18 AWG 600 V, 105 °C are required for installation. The unit will self-activate when AC power is applied for the first time.

## Specifications:

Emergency lighting shall be provided by using the AC Electronics **ACEPX16T1555CP** Linear Emergency LED Driver with a compatible LED fixture. The **ACEPX16T1555CP** shall contain a Lithium-ion battery with a nominal voltage of 10.8 V and 5000 mAh capacity, a high-efficiency battery charger, control circuitry, a high-efficiency two-wire universal input converter (120 through 277 Vac), high-efficiency output LED driver with soft-switching technology to prevent noise to protect LED modules, in a two-piece modular arrangement of two separate metal enclosures. A separate miniature illuminated test switch status indicator with installation hardware shall be provided for the purposes of performing periodic testing and

indicate status change of the battery and battery-charger. The **ACEPX16T1555CP** Emergency LED Driver shall be capable of delivering a constant power of 16 W to an LED load of 15 – 55 V for a minimum of 90 minutes. The **ACEPX16T1555CP** Linear Emergency LED Driver shall have a maximum of 11 W input power and shall comply with emergency standards established by the current NEC and shall meet CEC Title 20 (California Energy Commission) efficiency standards. The **ACEPX16T1555CP** Linear Emergency LED Driver shall comply with part 15 of the FCC Rules. The **ACEPX16T1555CP** Linear Emergency LED Driver shall be UL Listed for field or factory installation. The **ACEPX16T1555CP** is suitable for indoor and damp locations.

For questions or to place an order contact us at [oemsales@aceleds.com](mailto:oemsales@aceleds.com) or 800-375-6355 or your local WPG Americas Sales representative at [inquiry@wpgamericas.com](mailto:inquiry@wpgamericas.com) or 888-WPG8881

## Wiring Diagrams for Operating One Single Fixture

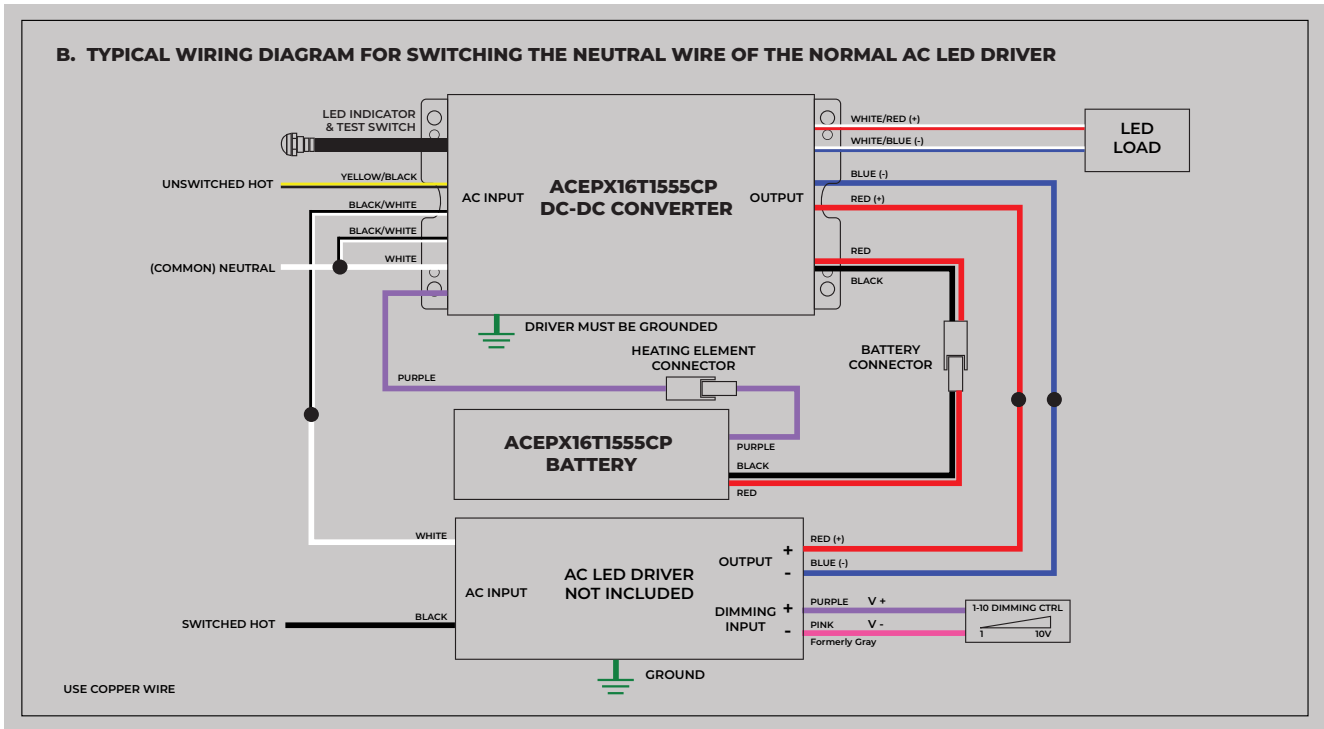
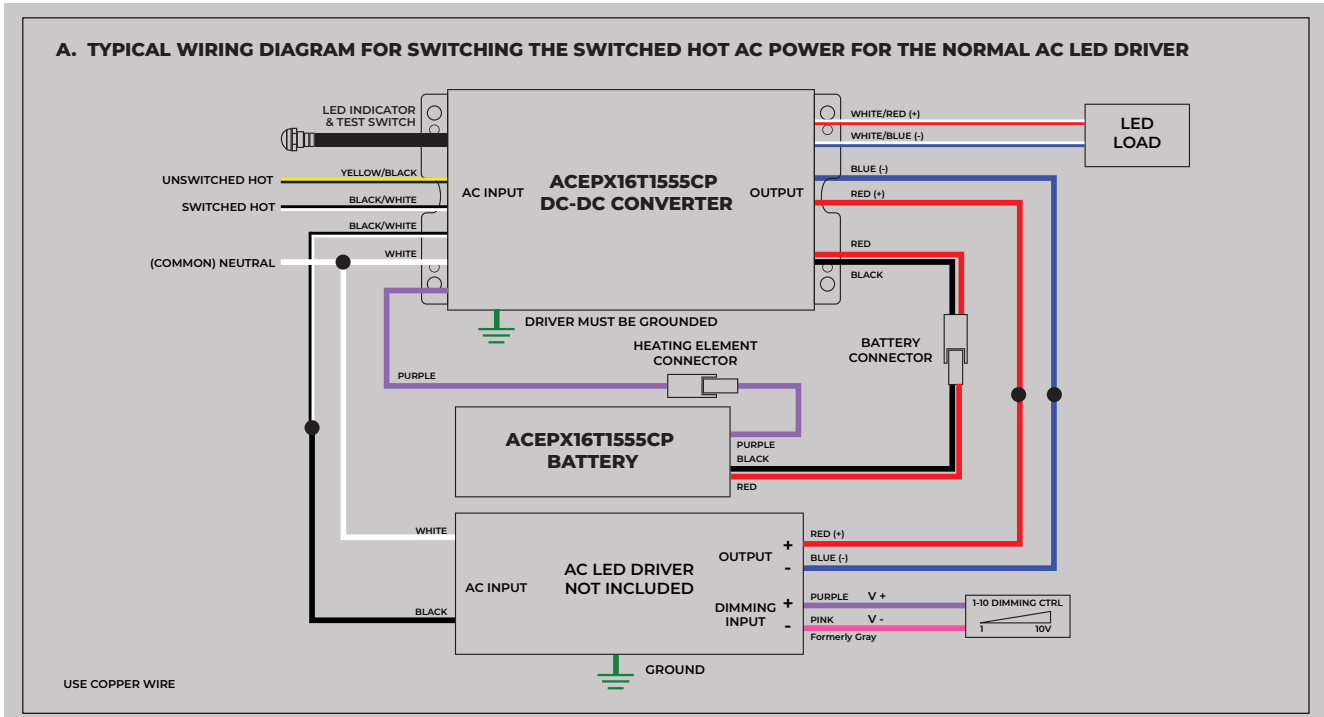

\*AC Electronics/ACE LEDS warrants to the purchaser that each Emergency LED Driver will be free from defects in material or workmanship for a period of 5 years when operated at max case temp of up to <60°C and 3 years warranty based on a maximum case temperature of ≤ 66 °C when properly installed and under normal conditions of use. See [aceleds.com](http://aceleds.com) for complete warranty policy.

For questions or to place an order contact us at [oemsales@aceleds.com](mailto:oemsales@aceleds.com) or 800-375-6355 or your local WPG Americas Sales representative at [inquiry@wpgamericas.com](mailto:inquiry@wpgamericas.com) or 888-WPG8881